

FITTINGS & GAUGES

UP TO 15,000 PSI (1000 BAR)



PRESSURE GAUGES

- Bottom mount
- 4" high visibility face with laminated safety glass dial cover
- Accurate within +/-0.5% of full scale range
- Stainless steel case, fitting and internals
- Heavy-duty movement
- Glycerin-filled for protection against vibration and pulsation
- Restrictor screw provides maximum protection against pulsation
- Blow-out pressure relief plug for maximum safety
- Pointer zero adjustment



Part No.	Dial Size		Mounting Style	Connection Type*	Units	Scale	Graduations	Maximum Operating Pressure	
	in	mm						psi	bar
25771	4	100	Bottom	1/2" NPTM	psi	0 — 20,000 psi	200 psi	10,000	700
51126	4	100	Bottom	1/2" NPTM	psi	0 — 30,000 psi	200 psi	15,000	1000
55416**	4	100	Bottom	1/2" NPTM	psi/bar	0 — 30,000 psi 0 — 2000 bar	500 psi 20 bar	15,000	1000
29818	4	100	Bottom	9/16" HP Male	psi/bar	0 — 30,000 psi 0 — 2000 bar	500 psi 20 bar	15,000	1000

* See details on all connection types beginning on page I-2.

** Includes adapter, gland nut and collar to adapt from 9/16" HP tube nipple.

Accessories

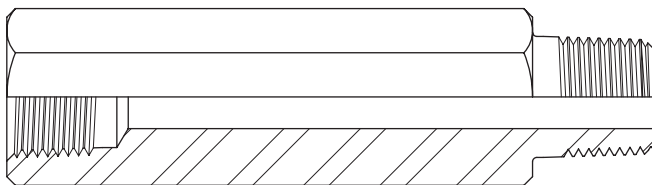

GAUGE EXTENSION

- Raises height of gauge for unobstructed reading
- 1/2" NPTM x 1/2" NPTF
- 4-1/2" (114 mm) lg.
- Stainless steel
- Copper-plated for galling resistance

Part No. 55176

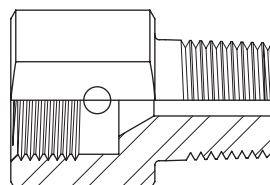

GAUGE ADAPTER

- Connects gauge (part no. 29818) to 1/2" NPTF port
- 1/2" NPTM x 9/16" MP female
- Small I.D. for proper seating of 9/16" HP tube nipple
- 9/16" MP gland nut and collar sold separately
- Stainless steel
- Copper-plated for galling resistance

Part No. 55402

FITTINGS & GAUGES

UP TO 15,000 PSI (1000 BAR)

THREAD LUBRICANTS

Thread Lubricants prevent threaded connections from galling together or seizing up, and are a necessary protection for stainless steel threaded components.



SILVER-BASED ANTI-SEIZE

.7 oz. Stick

Bottom twists to extend a solid, rub-on thread lubricant for easy, mess free application.

Part No. 29057



BLUE GOOP THREAD LUBRICANT

2 oz. Tube

Part No. 27721

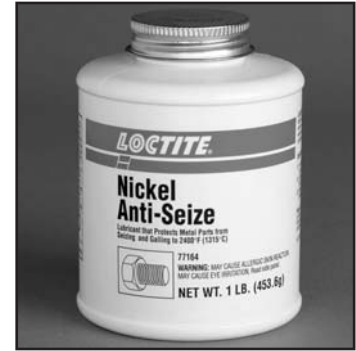

NICKEL-BASED ANTI-SEIZE

1 lb. Brush Top Can

Part No. 28197

TEFLON TAPE



1/2" x 520" roll

For use on pipe thread (NPT) connections.

Part No. 40282

TWIS-LOK QUICK CONNECT COUPLINGS

- Rugged Acme threads allow easy, hand-tight connection of hoses and other components
- Garter spring-locking mechanism prevents loosening during operation
- Easily replaceable seal assembly is hydraulically-biased for sure sealing
- 3/8" and 1/2" coupling halves are interchangeable and use the same seal assembly
- Stainless steel

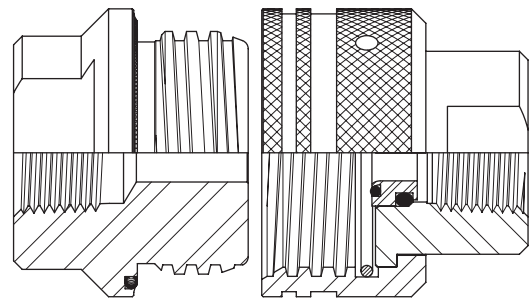

Part No.	Connection Type*	Coupling Halves		Seal Assembly	Maximum Operating Pressure	
		Male	Female**		psi	bar
52663	1" NPTF	52662	52677	52657	15,000	1000
51405	3/4" NPTF	51334	51665	51624	15,000	1000
51402	1/2" NPTF	51408	51670	51628	15,000	1000
51552	3/8" NPTF	51550	51554	51628	15,000	1000

* See details on all connection types beginning on page I-2.

** Female coupling halves include seal assembly.

FITTINGS & GAUGES

UP TO 15,000 PSI (1000 BAR)



SCREW TYPE QUICK CONNECT COUPLINGS PARTEK STYLE

- Easy, hand-tight connection of hoses and other components
- 3/8" and 1/2" NPT coupling halves are interchangeable
- 1" Type M, 3/4" Type M and 9/16" MP coupling halves are interchangeable
- Seal kits include O-ring seal and backup ring
- Stainless steel

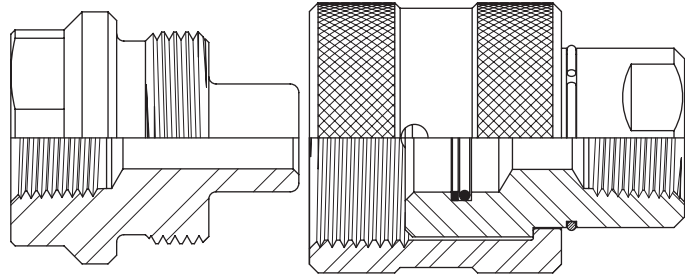

Part No.	Connection Type*	Coupling Halves		Seal Kit	Retaining Ring	Maximum Operating Pressure	
		Male	Female**			psi	bar
28921	1" NPTF	28921M	28921F	28921S	J70380	15,000	1000
28844	3/4" NPTF	28844M	28844F	28844S	J70381	15,000	1000
50989	1/2" NPTF	50990	52684	50989S	25690	15,000	1000
54180	3/8" NPTF	54178	54180F	50989S	25690	15,000	1000
54754	1" Type M Male	54762	54763	54789	25690	20,000	1400
54767	3/4" Type M Male	54758	54764	54789	25690	20,000	1400
54768	9/16" MP Female	54761	54766	54789	25690	20,000	1400

* See details on all connection types beginning on page I-2.
** Female coupling halves include seals.

LUG STYLE QUICK CONNECT COUPLINGS

- Spring-loaded sleeve retracts for easy connection of hoses and other components
- Safety pin prevents accidental disconnect
- 3/8" and 1/2" coupling halves are interchangeable and use the same seal assembly
- Plated steel

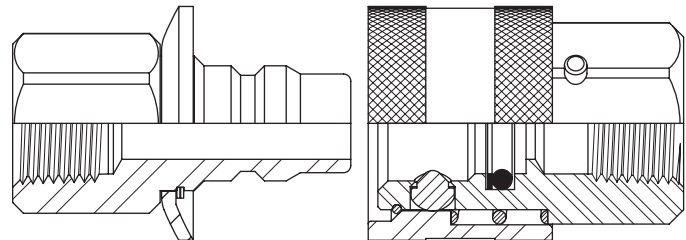

Part No.	Connection Type*	Coupling Halves		Maximum Operating Pressure	
		Male	Female**	psi	bar
50557	1/2" NPTF	26175	26176	10,000	700
50906	3/8" NPTF	26181	26182	10,000	700

* See details on all connection types beginning on page I-2.
** Female coupling halves include seal assembly.

Replacement Parts

Part No. 25212 O-Ring
Part No. 26657 Backup Ring



FITTINGS & GAUGES

UP TO 15,000 PSI (1000 BAR)

CROSSES — PIPE THREAD (NPT)

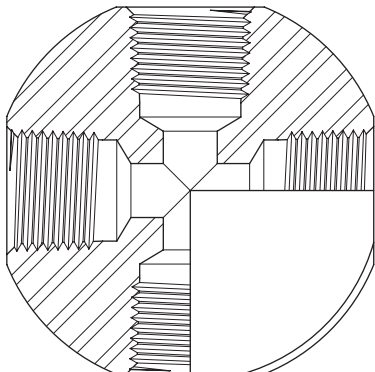
- Stainless steel





Part No.	Connection Type* 	Maximum Operating Pressure 	
		psi	bar
96048	1" NPTF	15,000	1000
54368	3/4" NPTF	15,000	1000
90262	1/2" NPTF	15,000	1000
29532	3/8" NPTF	15,000	1000
28577	1/4" NPTF	15,000	1000

* See details on all connection types beginning on page I-2.

TEES — PIPE THREAD (NPT)

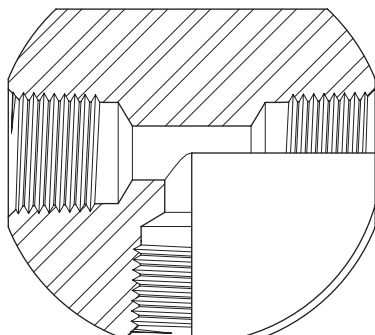
- Stainless steel





Part No.	Connection Type* 	Maximum Operating Pressure 	
		psi	bar
52673	1" NPTF	15,000	1000
50385	3/4" NPTF	15,000	1000
51001	1/2" NPTF	15,000	1000
50354	3/8" NPTF	15,000	1000
26166	1/4" NPTF	15,000	1000
26171	1/8" NPTF	15,000	1000

* See details on all connection types beginning on page I-2.

90° ELBOWS — PIPE THREAD (NPT)

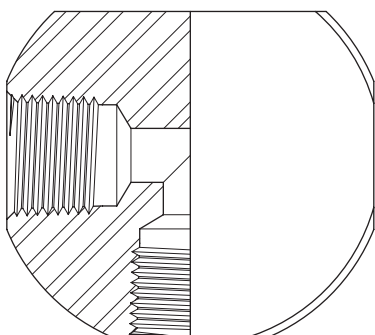
- Stainless steel



Part No.	Connection Type* 	Maximum Operating Pressure 	
		psi	bar
52672	1" NPTF	15,000	1000
50336	3/4" NPTF	15,000	1000
50300	1/2" NPTF	15,000	1000
50298	3/8" NPTF	15,000	1000
26162	1/4" NPTF	15,000	1000
26173	1/8" NPTF	15,000	1000

* See details on all connection types beginning on page I-2.

FITTINGS & GAUGES



UP TO 15,000 PSI (1000 BAR)

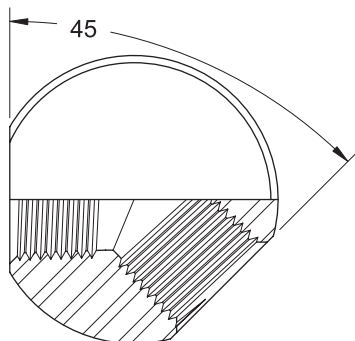

45° ELBOWS — PIPE THREAD (NPT)

- Stainless steel







Part No.	Connection Type* 	Maximum Operating Pressure 	
		psi	bar
50302	3/4" NPTF	15,000	1000
50824	1/2" NPTF	15,000	1000
50296	3/8" NPTF	15,000	1000

* See details on all connection types beginning on page I-2.

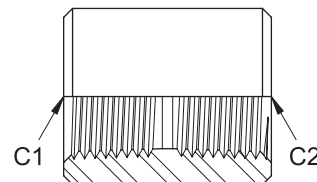
COUPLINGS — PIPE THREAD (NPT)

- Machined from heat-treated stainless steel to allow small outside diameters for tube cleaning.



Part No.	Connection Types* 		O.D. (D) 		Maximum Operating Pressure 	
	Connection 1 (C1)	Connection 2 (C2)	in	mm	psi	bar
52676	1" NPTF	1" NPTF	2.00	50.8	15,000	1000
28894	1" NPTF	3/4" NPTF	2.00	50.8	15,000	1000
J55701	1" NPTF	1/2" NPTF	2.00	50.8	15,000	1000
26055	3/4" NPTF	3/4" NPTF	1.50	38.1	15,000	1000
26067	3/4" NPTF	1/2" NPTF	1.50	38.1	15,000	1000
26059	3/4" NPTF	3/8" NPTF	1.50	38.1	15,000	1000
26056	1/2" NPTF	1/2" NPTF	1.19	30.2	15,000	1000
26072	1/2" NPTF	3/8" NPTF	1.19	30.2	15,000	1000
50342	1/2" NPTF	1/4" NPTF	1.25	31.8	15,000	1000
50059	1/2" NPTF	1/8" NPTF	1.19	30.2	15,000	1000
26057	3/8" NPTF	3/8" NPTF	.88	22.2	15,000	1000
26061	3/8" NPTF	1/4" NPTF	1.13	28.6	15,000	1000
26064	3/8" NPTF	1/8" NPTF	.94	23.8	15,000	1000
50816	1/4" NPTF	1/4" NPTF	.75	19.1	15,000	1000
50852	1/4" NPTF	1/8" NPTF	.75	19.1	15,000	1000
J55702	1/4" NPTF	1/16" NPTF	.75	19.1	15,000	1000
51191	1/8" NPTF	1/8" NPTF	.50	12.7	15,000	1000
50933	1/8" NPTF	1/16" NPTF	.50	12.7	15,000	1000
50638	1/16" NPTF	1/16" NPTF	.40	10.2	15,000	1000

* See details on all connection types beginning on page I-2.

FITTINGS & GAUGES

UP TO 15,000 PSI (1000 BAR)

HAMMER UNIONS – PIPE THREAD (NPT)

- Stainless steel



Part No.	Connection Type*	Seal	Maximum Operating Pressure	
			psi	bar
28319	1-1/4" NPTF	29319S	10,000	700
27181	1" NPTF	92011	10,000	700
50392	3/4" NPTF	50392S	10,000	700
29485	1/2" NPTF	29485S	10,000	700
29486	3/8" NPTF	29486S	10,000	700

* See details on all connection types beginning on page I-2.

REDUCING BUSHINGS – PIPE THREAD (NPT)

- Stainless steel
- Copper-plated for galling resistance

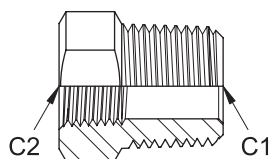

Part No.	Connection Types*		Maximum Operating Pressure	
	Connection 1 (C1)	Connection 2 (C2)	psi	bar
29054	2" NPTM	1-1/2" NPTF	7,500	500
J70392	2" NPTM	1" NPTF	7,500	500
28611	1-1/2" NPTM	1" NPTF	7,500	500
29828	1-1/4" NPTM	1" NPTF	7,500	500
26157	1" NPTM	3/4" NPTF	15,000	1000
26124	1" NPTM	1/2" NPTF	15,000	1000
26065	3/4" NPTM	1/2" NPTF	15,000	1000
26063	3/4" NPTM	3/8" NPTF	15,000	1000
26069	3/4" NPTM	1/4" NPTF	15,000	1000
26074	3/4" NPTM	1/8" NPTF	15,000	1000
26062	1/2" NPTM	3/8" NPTF	15,000	1000
25904	1/2" NPTM	1/4" NPTF	15,000	1000
25902	1/2" NPTM	1/8" NPTF	15,000	1000
53623	1/2" NPTM	1/16" NPTF	15,000	1000
25903	3/8" NPTM	1/4" NPTF	15,000	1000
25901	3/8" NPTM	1/8" NPTF	15,000	1000
28822	3/8" NPTM	1/16" NPTF	15,000	1000
26073	1/4" NPTM	1/8" NPTF	15,000	1000
J55719	1/4" NPTM	1/16" NPTF	15,000	1000
26158	1/8" NPTM	1/16" NPTF	15,000	1000

* See details on all connection types beginning on page I-2.



FITTINGS & GAUGES

UP TO 15,000 PSI (1000 BAR)

HEX NIPPLES – PIPE THREAD (NPT)

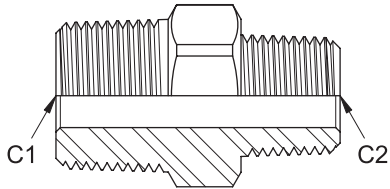
- Stainless steel nipples are copper plated for galling resistance



Part No.	Connection Types*		Material	Maximum Operating Pressure	
					
	Connection 1 (C1)	Connection 2 (C2)		psi	bar
J70382	2" NPTM	2" NPTM	Stainless Steel	7,500	500
J70383	2" NPTM	1-1/2" NPTM	Stainless Steel	7,500	500
29055	1-1/2" NPTM	1-1/2" NPTM	Stainless Steel	7,500	500
J70384	1-1/2" NPTM	1-1/4" NPTM	Stainless Steel	7,500	500
J70385	1-1/4" NPTM	1-1/4" NPTM	Stainless Steel	7,500	500
J70386	1-1/4" NPTM	1" NPTM	Stainless Steel	7,500	500
52674	1" NPTM	1" NPTM	Stainless Steel	15,000	1000
53054	1" NPTM	3/4" NPTM	Stainless Steel	15,000	1000
J70387	1" NPTM	1/2" NPTM	Stainless Steel	15,000	1000
26151	3/4" NPTM	3/4" NPTM	Stainless Steel	15,000	1000
51699	3/4" NPTM	3/4" NPTM	Plated Steel	15,000	1000
51702	3/4" NPTM	1/2" NPTM	Plated Steel	15,000	1000
J70388	3/4" NPTM	3/8" NPTM	Stainless Steel	15,000	1000
J70389	3/4" NPTM	1/4" NPTM	Stainless Steel	15,000	1000
50496	1/2" NPTM	1/2" NPTM	Plated Steel	15,000	1000
50488	1/2" NPTM	1/2" NPTM	Stainless Steel	15,000	1000
26153	1/2" NPTM	3/8" NPTM	Stainless Steel	15,000	1000
26084	1/2" NPTM	1/4" NPTM	Stainless Steel	15,000	1000
26154	1/2" NPTM	1/8" NPTM	Stainless Steel	15,000	1000
26152	3/8" NPTM	3/8" NPTM	Stainless Steel	15,000	1000
26155	3/8" NPTM	1/4" NPTM	Stainless Steel	15,000	1000
25454	3/8" NPTM	1/8" NPTM	Stainless Steel	15,000	1000
25455	1/4" NPTM	1/4" NPTM	Stainless Steel	15,000	1000
26075	1/4" NPTM	1/8" NPTM	Stainless Steel	15,000	1000
J70390	1/4" NPTM	1/16" NPTM	Stainless Steel	15,000	1000
25452	1/8" NPTM	1/8" NPTM	Stainless Steel	15,000	1000
26156	1/8" NPTM	1/16" NPTM	Stainless Steel	15,000	1000
J70391	1/16" NPTM	1/16" NPTM	Stainless Steel	15,000	1000

* See details on all connection types beginning on page I-2.

FITTINGS & GAUGES







UP TO 15,000 PSI (1000 BAR)

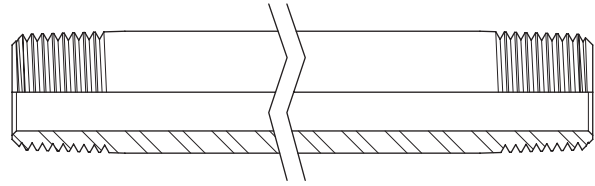

NIPPLES — PIPE THREAD (NPT)

- Stainless steel



Part No. specify length (in inches) in place of "XX"	Connection Type* 	O.D.		I.D.		Max. Working Pressure	
							
		in	mm	in	mm	psi	bar
J55703-XX	1" NPTM	1.315	33.4	.599	15.2	10,000	700
26146-XX	3/4" NPTM	1.050	26.7	.434	11.0	15,000	1000
28875-XX	3/4" NPTM	1.050	26.7	.614	15.6	10,000	700
55450-XX	1/2" NPTM	.840	21.3	.534	13.6	15,000	1000
51098-XX	3/8" NPTM	.675	17.1	.415	10.5	15,000	1000
51106-XX	1/4" NPTM	.540	13.7	.302	7.7	15,000	1000
25215-XX	1/8" NPTM	.405	10.3	.215	5.5	15,000	1000
51397-XX	1/16" NPTM	.312	7.9	.182	4.6	15,000	1000

* See details on all connection types beginning on page I-2.

Related Items

RIGID LANCES: PIPE THREADS — See page D-10

MEDIUM PRESSURE NIPPLES — See page F-18

PLUGS — PIPE THREAD (NPT)

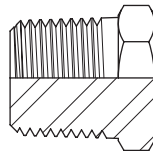

HEX HEAD

- Stainless steel plugs are copper plated for galling resistance



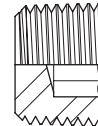

SOCKET HEAD



Part No.	Connection Type* 	Material	Maximum Operating Pressure	
				
			psi	bar
28602	1" NPTM	Stainless Steel	15,000	1000
26147	3/4" NPTM	Stainless Steel	15,000	1000
25174	1/2" NPTM	Plated Steel	15,000	1000
26148	3/8" NPTM	Plated Steel	15,000	1000
26149	1/4" NPTM	Plated Steel	15,000	1000
25120	1/8" NPTM	Plated Steel	15,000	1000

* See details on all connection types beginning on page I-2.

Part No.	Connection Type* 	Material	Maximum Operating Pressure	
				
			psi	bar
26164	3/4" NPTM	Plated Steel	15,000	1000
26115	1/2" NPTM	Plated Steel	15,000	1000
26077	3/8" NPTM	Plated Steel	15,000	1000
25392	1/4" NPTM	Plated Steel	15,000	1000
26170	1/8" NPTM	Plated Steel	15,000	1000
25395	1/16" NPTM	Plated Steel	15,000	1000

* See details on all connection types beginning on page I-2.

FITTINGS & GAUGES



UP TO 15,000 PSI (1000 BAR)

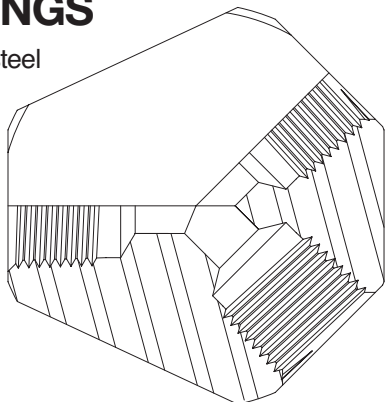

Y-FITTINGS

- Stainless steel





Part No.	Connection Type* 	Maximum Operating Pressure 	
		psi	bar
29678	1" NPTF	15,000	1000
70040	3/4" NPTF	15,000	1000
J70393	1/2" NPTF	15,000	1000

* See details on all connection types beginning on page I-2.

PIPE THREAD MALE TO STRAIGHT BOSS MALE ADAPTERS

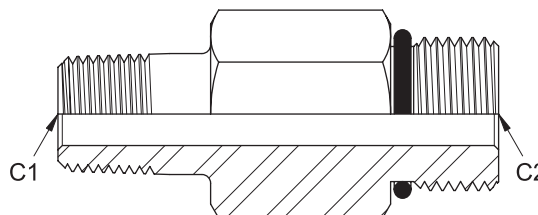
- Stainless steel
- Copper plated for galling resistance





Part No.	Connection Types* 		Replacement Seal	Maximum Operating Pressure 	
	Connection 1 (C1)	Connection 2 (C2)		psi	bar
50675	1/2" NPTM	#12 Straight Boss Male	25670	10,000	700

* See details on all connection types beginning on page I-2.

PIPE THREAD FEMALE TO STRAIGHT BOSS MALE ADAPTERS

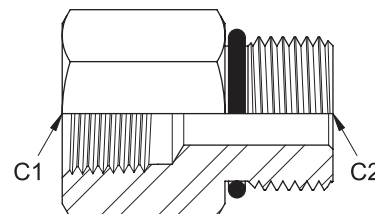
- Stainless steel



Part No.	Connection Types* 		Replacement Seal	Maximum Operating Pressure 	
	Connection 1 (C1)	Connection 2 (C2)		psi	bar
54909	1/2" NPTF	#12 Straight Boss Male	25670	10,000	700
50674	1/2" NPTF	#8 Straight Boss Male	25824	10,000	700

* See details on all connection types beginning on page I-2.

FITTINGS & GAUGES

UP TO 15,000 PSI (1000 BAR)



STRAIGHT BOSS PLUGS

- Stainless steel

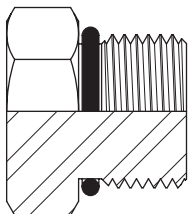

Part No.	Connection Type*	Replacement Seal	Maximum Operating Pressure	
			psi	bar
25702	#12 Straight Boss Male	25670	10,000	700
25703	#8 Straight Boss Male	25824	10,000	700

* See details on all connection types beginning on page I-2.

PIPE THREAD MALE (NPTM) TO TYPE M MALE ADAPTERS

- Stainless steel
- Copper plated for galling resistance

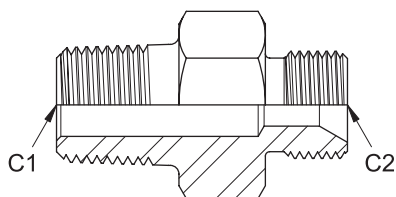

Part No.	Connection Types*		Maximum Operating Pressure	
	Connection 1 (C1)	Connection 2 (C2)	psi	bar
54719	1" NPTM	1-5/16" Type M Male	15,000	1000
J55704	1" NPTM	1" Type M Male	15,000	1000
28852	3/4" NPTM	1-5/16" Type M Male	15,000	1000
29178	3/4" NPTM	1" Type M Male	15,000	1000
J55706	3/4" NPTM	3/4" Type M Male	15,000	1000
J55707	3/4" NPTM	9/16" Type M Male	15,000	1000
29342	1/2" NPTM	1" Type M Male	15,000	1000
29185	1/2" NPTM	3/4" Type M Male	15,000	1000
28702	1/2" NPTM	9/16" Type M Male	15,000	1000
01437	3/8" NPTM	9/16" Type M Male	15,000	1000

* See details on all connection types beginning on page I-2.

PIPE THREAD FEMALE (NPTF) TO TYPE M MALE ADAPTERS

- Stainless steel

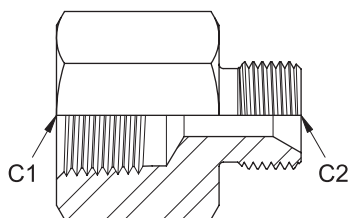

Part No.	Connection Types*		Maximum Operating Pressure	
	Connection 1 (C1)	Connection 2 (C2)	psi	bar
70167	1/2" NPTF	1" Type M Male	15,000	1000
29327	1/2" NPTF	3/4" Type M Male	15,000	1000
70168	3/8" NPTF	3/4" Type M Male	15,000	1000

* See details on all connection types beginning on page I-2.

FITTINGS & GAUGES

UP TO 15,000 PSI (1000 BAR)



PIPE THREAD MALE (NPTM) TO MEDIUM PRESSURE MALE ADAPTERS

- Stainless steel
- Copper plated for galling resistance

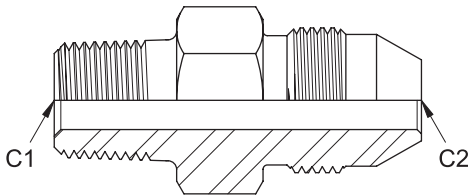

Part No.	Connection Types*		Maximum Operating Pressure	
	Connection 1 (C1)	Connection 2 (C2)	psi	bar
55033	1" NPTM	1" MP Male	15,000	1000
29669	1" NPTM	3/4" MP Male	15,000	1000
29316	1" NPTM	9/16" MP Male	15,000	1000
J55708	3/4" NPTM	1" MP Male	15,000	1000
29253	3/4" NPTM	3/4" MP Male	15,000	1000
29180	3/4" NPTM	9/16" MP Male	15,000	1000
28335	1/2" NPTM	1" MP Male	15,000	1000
28261	1/2" NPTM	3/4" MP Male	15,000	1000
27971	1/2" NPTM	9/16" MP Male	15,000	1000
29000	1/2" NPTM	3/8" MP Male	15,000	1000
J55709	3/8" NPTM	9/16" MP Male	15,000	1000
J55711	3/8" NPTM	3/8" MP Male	15,000	1000
29183	1/4" NPTM	9/16" MP Male	15,000	1000
28610	1/4" NPTM	3/8" MP Male	15,000	1000

* See details on all connection types beginning on page I-2.

PIPE THREAD FEMALE (NPTF) TO MEDIUM PRESSURE MALE ADAPTERS

- Stainless steel

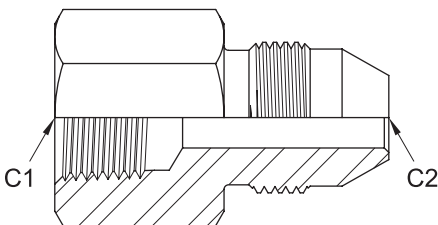

Part No.	Connection Types*		Maximum Operating Pressure	
	Connection 1 (C1)	Connection 2 (C2)	psi	bar
29534	3/4" NPTF	3/4" MP Male	15,000	1000
29673	1/2" NPTF	1" MP Male	15,000	1000
28903	1/2" NPTF	3/4" MP Male	15,000	1000
28334	1/2" NPTF	9/16" MP Male	15,000	1000
28003	1/2" NPTF	3/8" MP Male	15,000	1000
28386	3/8" NPTF	9/16" MP Male	15,000	1000
54958	3/8" NPTF	3/8" MP Male	15,000	1000
00451	1/4" NPTF	9/16" MP Male	15,000	1000

* See details on all connection types beginning on page I-2.

FITTINGS & GAUGES

UP TO 15,000 PSI (1000 BAR)



PIPE THREAD MALE (NPTM) TO MEDIUM PRESSURE FEMALE ADAPTERS

- Stainless steel
- Copper plated for galling resistance

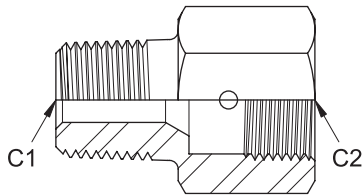

Part No.	Connection Types*		Maximum Operating Pressure	
	Connection 1 (C1)	Connection 2 (C2)	psi	bar
29392	3/4" NPTM	1" MP Female	15,000	1000
00111	3/4" NPTM	3/4" MP Female	15,000	1000
28092	1/2" NPTM	9/16" MP Female	15,000	1000
J55712	1/2" NPTM	3/8" MP Female	15,000	1000
J55713	3/8" NPTM	9/16" MP Female	15,000	1000
J55714	3/8" NPTM	3/8" MP Female	15,000	1000
J55716	1/4" NPTM	9/16" MP Female	15,000	1000
J55717	1/4" NPTM	3/8" MP Female	15,000	1000

* See details on all connection types beginning on page I-2.

PIPE THREAD FEMALE (NPTF) TO MEDIUM PRESSURE FEMALE ADAPTERS

- Stainless steel

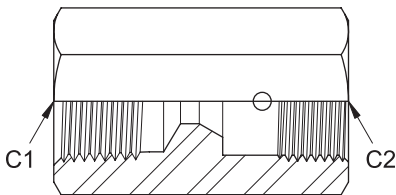

Part No.	Connection Types*		Maximum Operating Pressure	
	Connection 1 (C1)	Connection 2 (C2)	psi	bar
29186	3/4" NPTF	9/16" MP Female	10,000	700
29279	1/2" NPTF	3/4" MP Female	15,000	1000
29010	1/2" NPTF	9/16" MP Female	15,000	1000
28523	1/4" NPTF	9/16" MP Female	15,000	1000

* See details on all connection types beginning on page I-2.

PIPE THREAD MALE (NPTM) TO BRITISH STANDARD PIPE (BSP) MALE ADAPTERS

- Stainless steel
- Copper plated for galling resistance

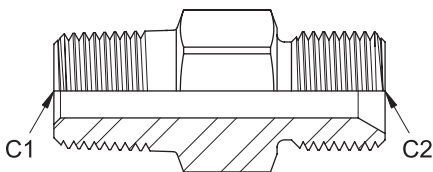

Part No.	Connection Types*		Maximum Operating Pressure	
	Connection 1 (C1)	Connection 2 (C2)	psi	bar
J55789	1" NPTM	G3/4" BSP Male	15,000	1000
55099	3/4" NPTM	G3/4" BSP Male	15,000	1000
55098	1/2" NPTM	G1/2" BSP Male	15,000	1000
55097	1/2" NPTM	G3/8" BSP Male	15,000	1000
55096	1/2" NPTM	G1/4" BSP Male	15,000	1000

* See details on all connection types beginning on page I-2.

FITTINGS & GAUGES

UP TO 15,000 PSI (1000 BAR)



PIPE THREAD FEMALE (NPTF) TO BRITISH STANDARD PIPE (BSP) MALE ADAPTERS

- Stainless steel

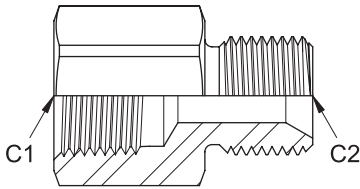

Part No.	Connection Types*		Maximum Operating Pressure	
	Connection 1 (C1)	Connection 2 (C2)	psi	bar
55224	1/2" NPTF	G1/2" BSP Male	15,000	1000

* See details on all connection types beginning on page I-2.

PIPE THREAD MALE (NPTM) TO METRIC MALE ADAPTERS

- Stainless steel
- Copper plated for galling resistance

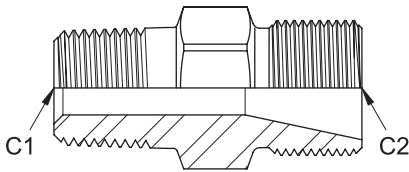

Part No.	Connection Types*		Maximum Operating Pressure	
	Connection 1 (C1)	Connection 2 (C2)	psi	bar
55094	3/4" NPTM	M36 x 2.0 Male	15,000	1000
55093	3/4" NPTM	M24 x 1.5 Male	15,000	1000
55092	1/2" NPTM	M24 x 1.5 Male	15,000	1000
55091	1/2" NPTM	M22 x 1.5 Male	15,000	1000

* See details on all connection types beginning on page I-2.

PIPE THREAD FEMALE (NPTF) TO METRIC MALE ADAPTERS

- Stainless steel

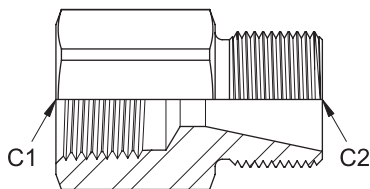

Part No.	Connection Types*		Maximum Operating Pressure	
	Connection 1 (C1)	Connection 2 (C2)	psi	bar
55223	1/2" NPTF	M24 x 1.5 Male	15,000	1000
55222	1/2" NPTF	M22 x 1.5 Male	15,000	1000

* See details on all connection types beginning on page I-2.

FITTINGS & GAUGES

UP TO 15,000 PSI (1000 BAR)



TYPE M MALE CONNECTORS

- Stainless steel

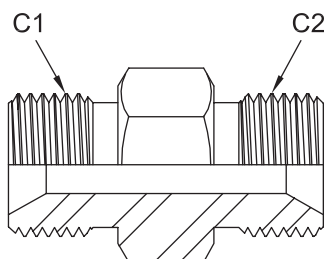

Part No.	Connection Types*		Maximum Operating Pressure	
	Connection 1 (C1)	Connection 2 (C2)	psi	bar
29058	1-5/16" Type M Male	1-5/16" Type M Male	20,000	1400
29059	1-5/16" Type M Male	1" Type M Male	20,000	1400
29060	1-5/16" Type M Male	3/4" Type M Male	20,000	1400
29061	1" Type M Male	1" Type M Male	20,000	1400
28487	1" Type M Male	3/4" Type M Male	20,000	1400
29019	1" Type M Male	9/16" Type M Male	20,000	1400
28196	3/4" Type M Male	3/4" Type M Male	20,000	1400
29062	3/4" Type M Male	9/16" Type M Male	20,000	1400
27527	9/16" Type M Male	9/16" Type M Male	40,000	2750

* See details on all connection types beginning on page I-2.

TYPE M MALE TO MEDIUM PRESSURE MALE CONNECTORS

- Stainless steel

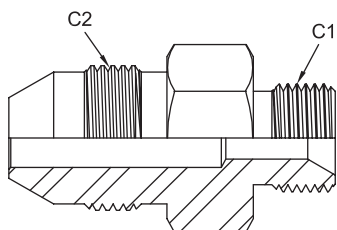

Part No.	Connection Types*		Maximum Operating Pressure	
	Connection 1 (C1)	Connection 2 (C2)	psi	bar
28330	1-5/16" Type M Male	1" MP Male	20,000	1400
28786	1-5/16" Type M Male	3/4" MP Male	20,000	1400
28299	1-5/16" Type M Male	9/16" MP Male	20,000	1400
28433	1" Type M Male	1" MP Male	20,000	1400
28629	1" Type M Male	3/4" MP Male	20,000	1400
28631	1" Type M Male	9/16" MP Male	20,000	1400
29063	3/4" Type M Male	1" MP Male	20,000	1400
29064	3/4" Type M Male	3/4" MP Male	20,000	1400
28350	3/4" Type M Male	9/16" MP Male	20,000	1400
29065	3/4" Type M Male	3/8" MP Male	20,000	1400
29066	9/16" Type M Male	1" MP Male	20,000	1400
28804	9/16" Type M Male	3/4" MP Male	20,000	1400
28193	9/16" Type M Male	9/16" MP Male	20,000	1400
28192	9/16" Type M Male	3/8" MP Male	20,000	1400
28328	9/16" Type M Male	1/4" MP Male	20,000	1400



* See details on all connection types beginning on page I-2.

FITTINGS & GAUGES

UP TO 15,000 PSI (1000 BAR)

MEDIUM PRESSURE CROSSES

- All medium pressure crosses include gland nuts and collars
- Stainless steel

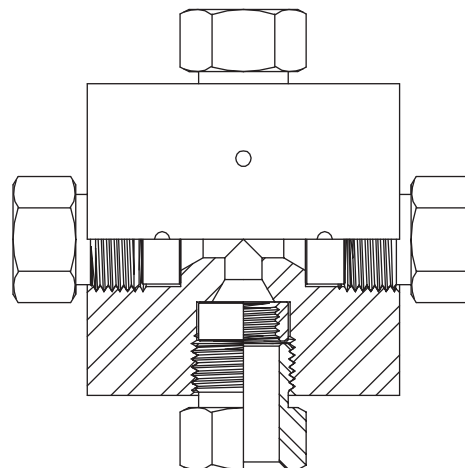

Part No.	Connection Type* 	Maximum Operating Pressure 	
		psi	bar
28301	1" MP Female	20,000	1400
29067	3/4" MP Female	20,000	1400
27969	9/16" MP Female	20,000	1400
29068	3/8" MP Female	20,000	1400
29069	1/4" MP Female	20,000	1400

* See details on all connection types beginning on page I-2.



MEDIUM PRESSURE TEES

- All medium pressure tees include gland nuts and collars
- Stainless steel

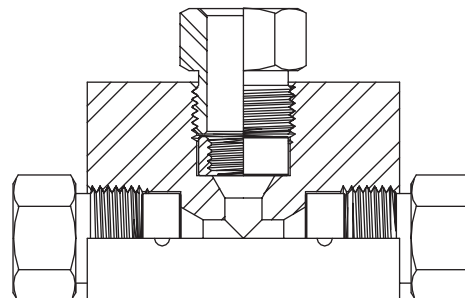

Part No.	Connection Type* 	Maximum Operating Pressure 	
		psi	bar
29070	1" MP Female	20,000	1400
29071	3/4" MP Female	20,000	1400
27966	9/16" MP Female	20,000	1400
27964	3/8" MP Female	20,000	1400
29072	1/4" MP Female	20,000	1400

* See details on all connection types beginning on page I-2.



MEDIUM PRESSURE ELBOWS

- All medium pressure elbows include gland nuts and collars
- Stainless steel

Part No.	Connection Type* 	Maximum Operating Pressure 	
		psi	bar
29073	1" MP Female	20,000	1400
29074	3/4" MP Female	20,000	1400
28184	9/16" MP Female	20,000	1400
27997	3/8" MP Female	20,000	1400
29075	1/4" MP Female	20,000	1400

* See details on all connection types beginning on page I-2.

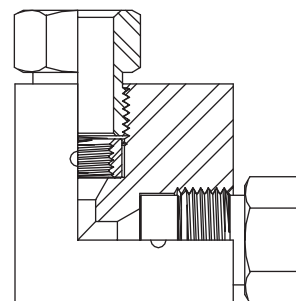

FITTINGS & GAUGES

UP TO 15,000 PSI (1000 BAR)



MEDIUM PRESSURE STRAIGHT COUPLINGS

- All medium pressure straight couplings include gland nuts and collars
- Stainless steel

Part No.	Connection Types*		Maximum Operating Pressure	
	Connection 1 (C1)	Connection 2 (C2)	psi	bar
28341	1" MP Female	1" MP Female	20,000	1400
29076	1" MP Female	3/4" MP Female	20,000	1400
29077	1" MP Female	9/16" MP Female	20,000	1400
28382	3/4" MP Female	3/4" MP Female	20,000	1400
29078	3/4" MP Female	9/16" MP Female	20,000	1400
29079	3/4" MP Female	3/8" MP Female	20,000	1400
27009	9/16" MP Female	9/16" MP Female	20,000	1400
28189	9/16" MP Female	3/8" MP Female	20,000	1400
28188	9/16" MP Female	1/4" MP Female	20,000	1400
28185	3/8" MP Female	3/8" MP Female	20,000	1400
28187	3/8" MP Female	1/4" MP Female	20,000	1400
29080	1/4" MP Female	1/4" MP Female	20,000	1400

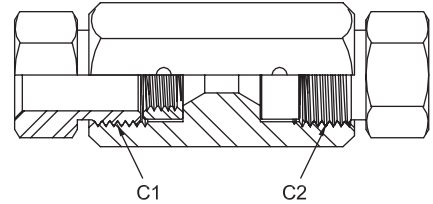

* See details on all connection types beginning on page I-2.

MEDIUM PRESSURE UNION COUPLINGS

Union couplings feature a removable seat insert that allows the fitting to slip over one end of the tubing for ease of installation in confined spaces or rigid piping applications.

- All medium pressure union couplings include gland nuts and collars
- Stainless steel

Part No.	Connection Type*	Maximum Operating Pressure	
		psi	bar
29081	1" MP Female	20,000	1400
29082	3/4" MP Female	20,000	1400
29083	9/16" MP Female	20,000	1400
29084	3/8" MP Female	20,000	1400
29119	1/4" MP Female	20,000	1400

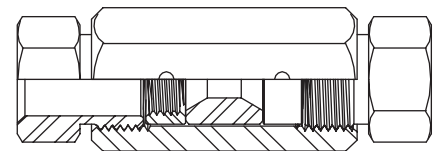

* See details on all connection types beginning on page I-2.

FITTINGS & GAUGES

UP TO 15,000 PSI (1000 BAR)



MEDIUM PRESSURE MALE CONNECTORS

Stainless steel

Part No.	Connection Types*		Maximum Operating Pressure	
	Connection 1 (C1)	Connection 2 (C2)	psi	bar
29085	1" MP Male	1" MP Male	20,000	1400
29086	1" MP Male	3/4" MP Male	20,000	1400
29087	1" MP Male	9/16" MP Male	20,000	1400
29088	3/4" MP Male	3/4" MP Male	20,000	1400
29089	3/4" MP Male	9/16" MP Male	20,000	1400
29090	3/4" MP Male	3/8" MP Male	20,000	1400
29715	3/4" MP Male	1/4" MP Male	20,000	1400
29091	9/16" MP Male	9/16" MP Male	20,000	1400
29092	9/16" MP Male	3/8" MP Male	20,000	1400
29093	9/16" MP Male	1/4" MP Male	20,000	1400
28191	3/8" MP Male	3/8" MP Male	20,000	1400
28190	3/8" MP Male	1/4" MP Male	20,000	1400
29094	1/4" MP Male	1/4" MP Male	20,000	1400

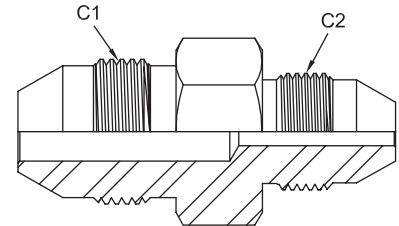

* See details on all connection types beginning on page I-2.

MEDIUM PRESSURE MALE TO MEDIUM PRESSURE FEMALE CONNECTORS

Stainless steel

Part No.	Connection Types*		Maximum Operating Pressure	
	Connection 1 (C1)	Connection 2 (C2)	psi	bar
29095	1" MP Male	3/4" MP Female	20,000	1400
28797	1" MP Male	9/16" MP Female	20,000	1400
28462	3/4" MP Male	9/16" MP Female	20,000	1400
29096	3/4" MP Male	3/8" MP Female	20,000	1400
28186	9/16" MP Male	3/8" MP Female	20,000	1400
28726	9/16" MP Male	1/4" MP Female	20,000	1400
29097	3/8" MP Male	1/4" MP Female	20,000	1400

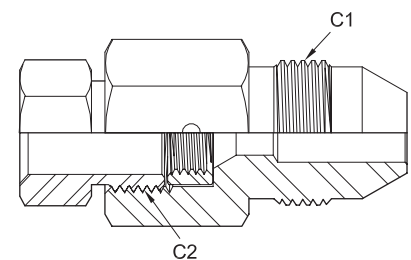

* See details on all connection types beginning on page I-2.

FITTINGS & GAUGES

UP TO 15,000 PSI (1000 BAR)



MEDIUM PRESSURE NIPPLES

- High tensile strength, cold drawn stainless steel
- Glands and collars not included





Left-hand Medium Pressure Tubing (MP Tube LH):

For use in standard medium pressure connections (using glands and collars) or with lance fittings (no glands and collars) or tube nozzles that have medium pressure, left-handed female threads. Available in 1/4" to 1" sizes.

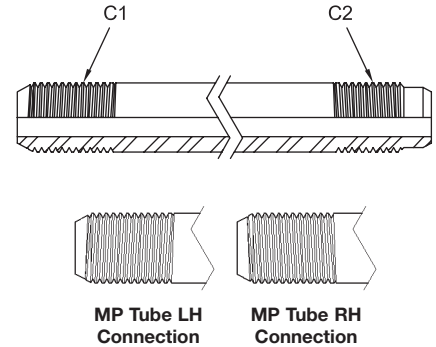
Right-hand Medium Pressure Tubing (MP Tube RH):

For use with lance fittings (no glands and collars) or tube nozzles that have medium pressure, right-handed female threads. Available in 1/4" to 3/4" sizes.



Part No. Specify length (in inches) in place of "XX"	Connection Types*		O.D.		I.D.		Max. Working Pressure	
								
	Connection 1 (C1)	Connection 2 (C2)	in	mm	in	mm	psi	bar
29013-XX	1" MP Tube LH Male	1" MP Tube LH Male	.990	25.1	.688	17.5	20,000	1400
29108-XX	3/4" MP Tube LH Male	3/4" MP Tube LH Male	.740	18.8	.438	11.1	20,000	1400
29109-XX	3/4" MP Tube LH Male	3/4" MP Tube RH Male	.740	18.8	.438	11.1	20,000	1400
29110-XX	3/4" MP Tube RH Male	3/4" MP Tube RH Male	.740	18.8	.438	11.1	20,000	1400
27968-XX	9/16" MP Tube LH Male	9/16" MP Tube LH Male	.553	14.0	.312	7.9	20,000	1400
54769-XX	9/16" MP Tube LH Male	9/16" MP Tube RH Male	.553	14.0	.312	7.9	20,000	1400
54781-XX	9/16" MP Tube RH Male	9/16" MP Tube RH Male	.553	14.0	.312	7.9	20,000	1400
27960-XX	3/8" MP Tube LH Male	3/8" MP Tube LH Male	.368	9.3	.203	5.2	20,000	1400
54783-XX	3/8" MP Tube LH Male	3/8" MP Tube RH Male	.368	9.3	.203	5.2	20,000	1400
54784-XX	3/8" MP Tube RH Male	3/8" MP Tube RH Male	.368	9.3	.203	5.2	20,000	1400
54787-XX	1/4" MP Tube LH Male	1/4" MP Tube LH Male	.245	6.2	.109	2.8	20,000	1400
54788-XX	1/4" MP Tube LH Male	1/4" MP Tube RH Male	.245	6.2	.109	2.8	20,000	1400
54789-XX	1/4" MP Tube RH Male	1/4" MP Tube RH Male	.245	6.2	.109	2.8	20,000	1400

* See details on all connection types beginning on page I-2.

Related Items

NIPPLES – PIPE THREAD (NPT) — See page F-8

MEDIUM PRESSURE GLAND NUTS, COLLARS AND PLUGS

Connection Type*	Part No.		
	Gland Nut	Collar	Plug
1" MP Male	28731	28732	29100
3/4" MP Male	28383	28384	29101
9/16" MP Male	26645	26635	27973
3/8" MP Male	28181	28180	28229
1/4" MP Male	29098	29099	29102

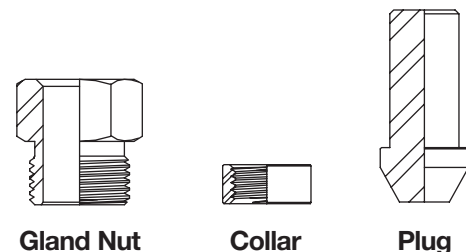

* See details on all connection types beginning on page I-2.

FITTINGS & GAUGES

UP TO 15,000 PSI (1000 BAR)



MEDIUM PRESSURE ANTI-VIBRATION GLAND ASSEMBLIES

Used to reduce stress on tubing threads in conditions where bending or vibration are present, anti-vibration gland assemblies feature a collet that clamps onto the tubing when the connection is tightened to provide extra support and strength.

Assembly Part No.	Connection Type* 	Replacement Part No.			
		Gland Nut	Collet	Collar	Collet Nut
29103	1" MP Male	29103G	29103C	28732	29103R
29104	3/4" MP Male	29104G	29104C	28384	29104R
28268	9/16" MP Male	28268G	28268C	26635	28268R
29105	3/8" MP Male	29105G	29105C	28180	29105R
29106	1/4" MP Male	29106G	29106C	29099	29106R

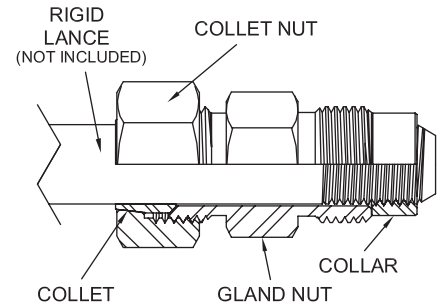



* See details on all connection types beginning on page I-2.

MEDIUM PRESSURE SLIMLINE LANCE COUPLINGS

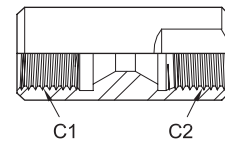
- Used to couple medium pressure rigid and flex lances without the use of glands and collars, allowing them to fit into tubes
- Additional couplings available by request
- Heat-treated stainless steel



Part No.	Connection Types* 		O.D. (D) 		Max. Working Pressure 	
	Connection 1 (C1)	Connection 2 (C2)	in	mm	psi	bar
	28668	9/16" MP Tube LH Female	9/16" MP Tube LH Female	.750	19.1	20,000
29111	9/16" MP Tube LH Female	9/16" MP Tube RH Female	.750	19.1	20,000	1400
29112	9/16" MP Tube RH Female	9/16" MP Tube RH Female	.750	19.1	20,000	1400
28349	9/16" MP Tube LH Female	3/8" MP Tube LH Female	.750	19.1	20,000	1400
28314	9/16" MP Tube RH Female	3/8" MP Tube RH Female	.750	19.1	20,000	1400
28667	3/8" MP Tube LH Female	3/8" MP Tube LH Female	.500	12.7	20,000	1400
29113	3/8" MP Tube LH Female	3/8" MP Tube RH Female	.500	12.7	20,000	1400
29114	3/8" MP Tube RH Female	3/8" MP Tube RH Female	.500	12.7	20,000	1400
28315	3/8" MP Tube RH Female	1/4" MP Tube RH Female	.500	12.7	20,000	1400
28666	1/4" MP Tube LH Female	1/4" MP Tube LH Female	.375	9.5	20,000	1400
28700	1/4" MP Tube LH Female	1/4" MP Tube RH Female	.375	9.5	20,000	1400
29115	1/4" MP Tube RH Female	1/4" MP Tube RH Female	.375	9.5	20,000	1400

* See details on all connection types beginning on page I-2.

FITTINGS & GAUGES

UP TO 15,000 PSI (1000 BAR)



RIGID LANCE ADAPTERS — MACHINE SCREW FEMALE TO PIPE THREAD MALE (NPTM)

- Used to connect small diameter rigid lances with machine screw threads (see page D-11) to pipe threaded hoses and fittings
- Stainless steel
- Copper plated for galling resistance

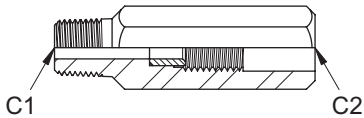

Part No.	Connection Types*		Maximum Operating Pressure	
	Connection 1 (C1)	Connection 2 (C2)	psi	bar
51039	1/8" NPTM	1/4-28UNF Female	10,000	700
51041	1/8" NPTM	5/16-24UNF Female	10,000	700
51043	1/8" NPTM	3/8-24UNF Female	10,000	700

* See details on all connection types beginning on page I-2.

Related Items

RIGID LANCES: MACHINE SCREW THREADS — See page D-11

MS NOZZLES — See page E-28

DUAL LANCE MANIFOLDS — PIPE THREAD (NPT)

- Allows simultaneous operation of two lances
- Stainless steel

Part No.	Connection Types*		Maximum Operating Pressure	
	Inlet Connection	Lance Connections (2)	psi	bar
50999	1/2" NPTF	1/4" NPTF	15,000	1000
50585	1/2" NPTF	1/8" NPTF	15,000	1000
51401	1/2" NPTF	1/16" NPTF	15,000	1000

* See details on all connection types beginning on page I-2.

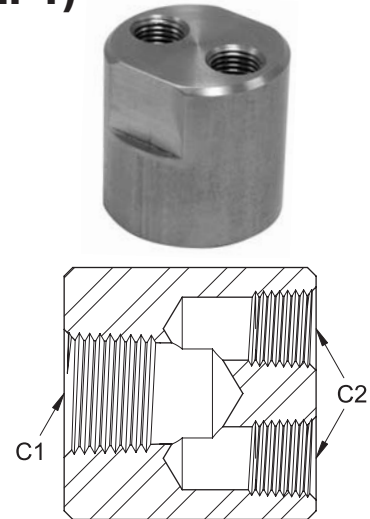

Related Items

RIGID LANCES: PIPE THREADS — See page D-10